

Ruedas **Twin-Lex**

Fabricadas por la fábrica asociada de Alex en China y con controles Alex













Serie 110
Serie 111
Serie 120
Serie 121
Serie 122
Serie 200
Serie 201
Serie 300
Serie 301
Serie 310
Serie 400
Serie 411
Serie 415
Serie 420
Serie 500
Serie 501
Serie 502

Aro Serie 110

Rueda de polipropileno especial para carros
 Cojinete: rodillos
 Diámetros: 125mm
 Capacidad de carga: 280Kg

Horquilla Serie 110

Chapa de acero embutida
 Acabado: Cincado brillante
 Tipo de fijación: pletina (giratoria y fija)
 Doble rodamiento a bolas
 Protector anti-polvo











| | Código |  |  Kg |  | Tipo Cojinete Eje |  |  |  |  |
|--|---------------|---|--|---|---|---|---|---|---|
|  | TW0022 | 125 | 280 | 40 |  | 135x110 | 105x80/70 | M10 | 156 |
|  | TW0023 | 125 | 280 | 40 |  | 132x111 | 105x80/70 | M10 | 156 |

Aro Series 111

Núcleo de aluminio y banda de goma elástica
 Cojinete: bolas
 Diámetros: 125mm
 Capacidad de carga: 300Kg

Horquilla Serie 111

Chapa de acero embutida
 Acabado: Cincado brillante
 Tipo de fijación: pletina (giratoria y fija)
 Doble rodamiento a bolas
 Protector anti-polvo

| | Código |  |  Kg |  | Tipo Cojinete Eje |  |  |  |  |
|---|---------------|---|--|---|---|---|---|---|---|
|  | TW0148 | 125 | 300 | 50 |  | 135x110 | 105x80/75 | M10 | 164 |
|  | TW0149 | 125 | 300 | 50 |  | 133x112 | 105x80/75 | M10 | 164 |

Serie 120

























Aro

Núcleo metálico y banda de goma
 Cojinete: rodillos
 Diámetros : 80 - 200mm
 Capacidad de carga: 70 - 205Kg
 Protectores anti-hilos

Horquilla

Chapa de acero embutida
 Acabado: cincado brillante
 Tipo de fijación: pletina (giratoria y fija)
 Doble rodamiento a bolas
 Protector anti-polvo

www.alex.es

| Código |  |  Kg |  | Tipo Cojinete Eje |  |  |  |  |
|---------------|---|--|---|---|---|---|---|---|
| TW0024 | 80 | 70 | 25 |  | 104x80 | 80x60/72x52 | M9 | 105 |
| TW0025 | 100 | 90 | 30 |  | 102x84 | 80x60/72x52 | M9 | 128 |
| TW0026 | 125 | 120 | 37 |  | 102x84 | 80x60/72x52 | M9 | 155 |
| TW0027 | 160 | 160 | 40 |  | 135x110 | 105x80 | M11 | 197 |
| TW0028 | 200 | 205 | 50 |  | 135x110 | 105x80 | M11 | 235 |
| TW0029 | 80 | 70 | 25 |  | 104x80 | 80x60/72x52 | M9 | 105 |
| TW0030 | 100 | 90 | 30 |  | 102x84 | 80x60/72x52 | M9 | 128 |
| TW0031 | 125 | 120 | 37 |  | 102x84 | 80x60/72x52 | M9 | 155 |
| TW0032 | 160 | 160 | 40 |  | 135x110 | 105x80 | M11 | 197 |
| TW0033 | 200 | 205 | 50 |  | 135x110 | 105x80 | M11 | 235 |
| TW0034 | 80 | 70 | 25 |  | 104x80 | 80x60/72x52 | M9 | 105 |
| TW0035 | 100 | 90 | 30 |  | 102x84 | 80x60/72x52 | M9 | 128 |
| TW0036 | 125 | 120 | 37 |  | 102x84 | 80x60/72x52 | M9 | 155 |
| TW0037 | 160 | 160 | 40 |  | 135x110 | 105x80 | M11 | 197 |
| TW0038 | 200 | 205 | 50 |  | 135x110 | 105x80 | M11 | 235 |



















Aro

Núcleo de polipropileno y banda de goma superelástica azul
 Cojinete: Rodillos
 Diámetros : 100-125mm
 Capacidad de carga: 100-130Kg

Horquilla

Chapa de acero embutida
 Acabado: cincado brillante
 Tipo de fijación: pletina (giratoria y fija)
 Doble rodamiento a bolas
 Protector anti-polvo

| | Código |  |  Kg |  | Tipo Cojinete Eje  |  |  |  |  |
|--|---------------|---|--|---|--|---|---|---|---|
|  | TW0039 | 100 | 100 | 30 |  | 102x84 | 80x60/72x52 | M9 | 128 |
| | TW0125 | 125 | 130 | 37 |  | 102x84 | 80x60/72x52 | M9 | 155 |
|  | TW0040 | 100 | 100 | 30 |  | 102x84 | 80x60/72x52 | M9 | 128 |
| | TW0126 | 125 | 130 | 37 |  | 102x84 | 80x60/72x52 | M9 | 155 |
|  | TW0041 | 100 | 100 | 30 |  | 102x84 | 80x60/72x52 | M9 | 128 |
| | TW0127 | 125 | 130 | 37 |  | 102x84 | 80x60/72x52 | M9 | 155 |

Serie 122

























Aro

Rueda de poliamix
Cojinete: rodillos
Diámetros: 80 - 200mm
Capacidad de carga: 130 - 280Kg
Protectores anti-hilos

Horquilla

Chapa de acero embutida
Acabado: cincado brillante
Tipo de fijación: pletina (giratoria y fija)
Doble rodamiento a bolas
Protector anti-polvo

www.alex.es

| Código |  |  Kg |  | Tipo Cojinete Eje |  |  |  |  |
|---------------|---|--|---|---|---|---|---|---|
| TW0042 | 80 | 130 | 35 |  | 104x80 | 80x60/72x52 | M9 | 105 |
| TW0043 | 100 | 150 | 35 |  | 102x84 | 80x60/72x52 | M9 | 128 |
| TW0044 | 125 | 170 | 40 |  | 102x84 | 80x60/72x52 | M9 | 155 |
| TW0045 | 160 | 200 | 40 |  | 135x110 | 105x80 | M11 | 197 |
| TW0046 | 200 | 280 | 45 |  | 135x110 | 105x80 | M11 | 235 |
| TW0047 | 80 | 130 | 35 |  | 104x80 | 80x60/72x52 | M9 | 105 |
| TW0048 | 100 | 150 | 35 |  | 102x84 | 80x60/72x52 | M9 | 128 |
| TW0049 | 125 | 170 | 40 |  | 102x84 | 80x60/72x52 | M9 | 155 |
| TW0050 | 160 | 200 | 40 |  | 135x110 | 105x80 | M11 | 197 |
| TW0051 | 200 | 280 | 45 |  | 135x110 | 105x80 | M11 | 235 |
| TW0052 | 80 | 130 | 35 |  | 104x80 | 80x60/72x52 | M9 | 105 |
| TW0053 | 100 | 150 | 35 |  | 102x84 | 80x60/72x52 | M9 | 128 |
| TW0054 | 125 | 170 | 40 |  | 102x84 | 80x60/72x52 | M9 | 155 |
| TW0055 | 160 | 200 | 40 |  | 135x110 | 105x80 | M11 | 197 |
| TW0056 | 200 | 280 | 45 |  | 135x110 | 105x80 | M11 | 235 |













Aro

Llanta metálica y cubierta de goma
 Diámetro: 200mm
 Capacidad de carga: 200Kg

Horquilla

Chapa de acero embutida
 Acabado: cincado brillante
 Tipo de fijación: espiga o cazoleta
 Doble rodamiento a bolas
 Con freno de doble acción - Sistema estándar

| | Código |  |  Kg |  | Tipo Cojinete Eje |  |  |  |  |
|---|---------------|---|--|---|---|---|---|---|---|
|  | TW0057 | 200 | 200 | 46 |  | - | - | 34x105 | - |
|  | TW0058 | 200 | 200 | 46 |  | - | - | 44x120 | - |

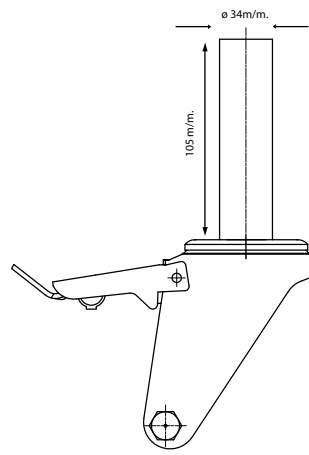
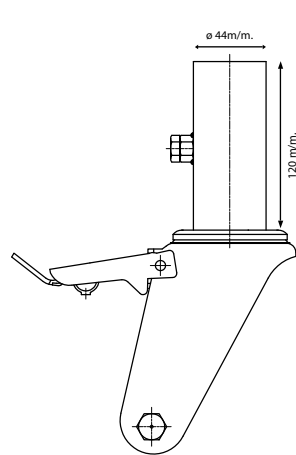

Serie 201



Aro

LLanta metálica y cubierta de goma
 Diámetro: 200mm
 Capacidad de carga: 200Kg

Horquilla

Chapa de acero embutida
 Acabado: cincado brillante
 Tipo de fijación: espiga o cazoleta
 Doble rodamiento a bolas
 Con freno de doble acción - Sistema europeo

www.alex.es

| Código | | | | Tipo Cojinete Eje | | | | |
|---------------|-----|-----|----|-------------------|---|---|--------|---|
| TW0059 | 200 | 200 | 46 | | - | - | 40x115 | - |



| | | | | | | | | |
|---------------|-----|-----|----|--|---|---|--------|---|
| TW0060 | 200 | 200 | 46 | | - | - | 51x115 | - |
|---------------|-----|-----|----|--|---|---|--------|---|

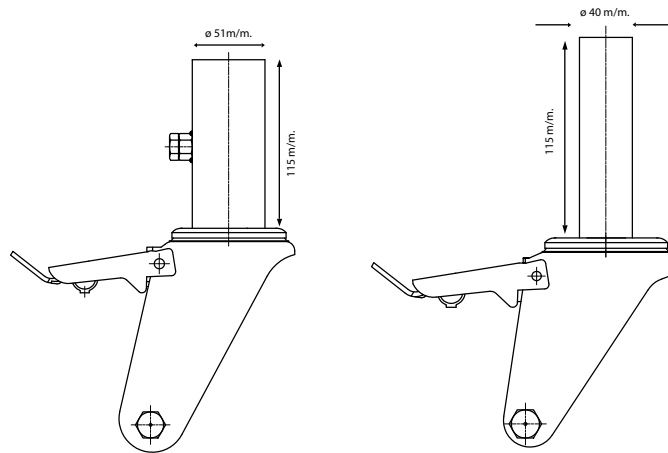



























Aro

Núcleo de polipropileno y banda de goma termoplástica
 Cojinete: bolas
 Diámetros: 100 - 125mm
 Capacidad de carga: 100Kg
 Protectores anti-hilos

Horquilla

Chapa de acero embutida
 Acabado: cincado brillante
 Tipo de fijación: pletina y agujero pasante
 Doble rodamiento a bolas

| | Código |  |  Kg |  | Tipo Cojinete Eje |  |  |  |  |
|--|---------------|---|--|---|---|---|---|---|---|
|  | TW0061 | 100 | 100 | 32 |  | 77x67 | 62x51/56x47 | M9 | 135 |
| | TW0062 | 125 | 100 | 32 |  | 77x67 | 62x51/56x47 | M9 | 160 |
|  | TW0063 | 100 | 100 | 32 |  | 77x67 | 62x51/56x47 | M9 | 135 |
| | TW0064 | 125 | 100 | 32 |  | 77x67 | 62x51/56x47 | M9 | 160 |
| | Código |  |  Kg |  | Tipo Cojinete Eje |  |  |  |  |
|  | TW0065 | 100 | 100 | 32 |  | - | - | 11 | 135 |
| | TW0066 | 125 | 100 | 32 |  | - | - | 11 | 160 |
|  | TW0067 | 100 | 100 | 32 |  | - | - | 11 | 135 |
| | TW0068 | 125 | 100 | 32 |  | - | - | 11 | 160 |

Serie 301



Aro

Núcleo de polipropileno y banda de goma termoplástica
 Cojinete: liso
 Diámetros: 100 - 125mm
 Capacidad de carga: 100Kg

Horquilla

Chapa de acero embutida
 Acabado: cincado brillante
 Tipo de fijación: pletina y agujero pasante
 Doble rodamiento a bolas

www.alex.es









| Código | | | | Tipo Cojinete Eje | | | | | |
|---------------|-----|-----|----|-------------------|-------|-------------|----|-----|--|
| TW0069 | 100 | 100 | 32 | — | 77x67 | 62x51/56x47 | M9 | 135 | |
| TW0070 | 125 | 100 | 32 | — | 77x67 | 62x51/56x47 | M9 | 160 | |
| TW0071 | 100 | 100 | 32 | — | 77x67 | 62x51/56x47 | M9 | 135 | |
| TW0072 | 125 | 100 | 32 | — | 77x67 | 62x51/56x47 | M9 | 160 | |
| Código | | | | Tipo Cojinete Eje | | | | | |
| TW0073 | 100 | 100 | 32 | — | - | - | 11 | 135 | |
| TW0074 | 125 | 100 | 32 | — | - | - | 11 | 160 | |
| TW0075 | 100 | 100 | 32 | — | - | - | 11 | 135 | |
| TW0076 | 125 | 100 | 32 | — | - | - | 11 | 160 | |

Aro









Núcleo de polipropileno y banda de goma gris
 Cojinete: liso
 Diámetros: 50 - 125mm
 Capacidad de carga: 25 - 80Kg
 Protectores anti-hilos

Horquilla

Chapa de acero embutida
 Acabado: cincado brillante
 Tipo de fijación: pletina o agujero pasante
 Doble rodamiento a bolas

| Código |  |  Kg |  | Tipo Cojinete Eje |  |  |  |  |
|--|---|--|---|-------------------|---|---|---|---|
|  TW0077 | 50 | 25 | 18 | — | 50x50 | 36x36 | M6 | 72 |
| TW0078 | 60 | 35 | 21 | — | 65x65 | 49x49 | M8 | 85 |
| TW0079 | 75 | 50 | 21 | — | 65x65 | 49x49 | M8 | 100 |
| TW0080 | 100 | 60 | 27 | — | 76x76 | 57x57 | M8 | 135 |
| TW0081 | 125 | 80 | 27 | — | 76x76 | 57x57 | M8 | 155 |

| | | | | | | | | |
|---|-----|----|----|---|-------|-------|----|-----|
|  TW0082 | 50 | 25 | 18 | — | 50x50 | 36x36 | M6 | 72 |
| TW0083 | 60 | 35 | 21 | — | 65x65 | 49x49 | M8 | 85 |
| TW0084 | 75 | 50 | 21 | — | 65x65 | 49x49 | M8 | 100 |
| TW0085 | 100 | 60 | 27 | — | 76x76 | 57x57 | M8 | 135 |
| TW0086 | 125 | 80 | 27 | — | 76x76 | 57x57 | M8 | 155 |

| Código |  |  Kg |  | Tipo Cojinete Eje |  |  |  |  |
|--|---|--|---|-------------------|---|---|---|---|
|  TW0087 | 50 | 25 | 18 | — | — | — | 10 | 72 |
| TW0088 | 60 | 35 | 21 | — | — | — | 10 | 85 |
| TW0089 | 75 | 50 | 21 | — | — | — | 10 | 100 |
| TW0090 | 100 | 60 | 27 | — | — | — | 10 | 135 |
| TW0091 | 125 | 80 | 27 | — | — | — | 12 | 155 |

| | | | | | | | | |
|--|-----|----|----|---|---|---|----|-----|
|  TW0092 | 50 | 25 | 18 | — | — | — | 10 | 72 |
| TW0093 | 60 | 35 | 21 | — | — | — | 10 | 85 |
| TW0094 | 75 | 50 | 21 | — | — | — | 10 | 100 |
| TW0095 | 100 | 60 | 27 | — | — | — | 10 | 135 |
| TW0096 | 125 | 80 | 27 | — | — | — | 12 | 155 |

Serie 400



Aro

Rueda de poliamida negra
Cojinete: liso
Diámetros: 50 - 100mm
Capacidad de carga: 40 - 60 Kg
Protectores anti-hilos

Horquilla

Chapa de acero embutida
Acabado: cincado brillante
Tipo de fijación: pletina o agujero pasante
Doble rodamiento a bolas

www.alex.es

| Código | | | | Tipo Cojinete Eje | | | | |
|---------------|-----|----|----|-------------------|-------|-------|---|-----|
| TW0136 | 50 | 40 | 20 | | 60X60 | 46X46 | - | 72 |
| TW0137 | 60 | 50 | 22 | | 60X60 | 46X46 | - | 82 |
| TW0138 | 75 | 50 | 24 | | 60X60 | 46X46 | - | 101 |
| TW0139 | 100 | 60 | 24 | | 60X60 | 46X46 | - | 121 |



| | | | | | | | | |
|---------------|-----|----|----|--|-------|-------|---|-----|
| TW0140 | 50 | 40 | 20 | | 60X60 | 46X46 | - | 72 |
| TW0141 | 60 | 50 | 22 | | 60X60 | 46X46 | - | 82 |
| TW0142 | 75 | 50 | 24 | | 60X60 | 46X46 | - | 101 |
| TW0143 | 100 | 60 | 24 | | 60X60 | 46X46 | - | 121 |



| Código | | | | Tipo Cojinete Eje | | | | |
|---------------|-----|----|----|-------------------|---|---|----|-----|
| TW0097 | 50 | 40 | 20 | | - | - | 10 | 72 |
| TW0098 | 60 | 50 | 22 | | - | - | 10 | 82 |
| TW0099 | 75 | 50 | 24 | | - | - | 10 | 101 |
| TW0100 | 100 | 60 | 24 | | - | - | 10 | 121 |



| | | | | | | | | |
|---------------|-----|----|----|--|---|---|----|-----|
| TW0144 | 50 | 40 | 20 | | - | - | 10 | 72 |
| TW0145 | 60 | 50 | 22 | | - | - | 10 | 82 |
| TW0146 | 75 | 50 | 24 | | - | - | 10 | 101 |
| TW0147 | 100 | 60 | 24 | | - | - | 10 | 121 |











Aro









Núcleo de polipropileno y banda de goma gris
 Cojinete: liso
 Diámetro: 50mm
 Capacidad de carga: 80Kg

Horquilla

Chapa de acero embutida
 Acabado: cincado brillante
 Tipo de fijación: pletina o agujero pasante
 Doble rodamiento a bolas

|  | Código |  |  |  | Tipo Cojinete Eje |  |  |  |  |
|--|--------|---|---|---|-------------------|---|---|---|---|
| | | | | | | | | | |
| X | | | | | | | | | |
| TW0101 | 50 | 80 | 20X2 | == | 60X60 | 43X43 | M6 | 76 | |
| | | | | | | | | | |

| | | | | | | | | | |
|---|---------------|----|----|------|----|-------|-------|----|----|
|  | TW0103 | 50 | 80 | 20X2 | == | 60X60 | 43X43 | M6 | 76 |
| | | | | | | | | | |

|  | Código |  |  |  | Tipo Cojinete Eje |  |  |  |  |
|--|--------|---|---|---|-------------------|---|---|---|---|
| | | | | | | | | | |
| TW0105 | 50 | 80 | 20X2 | == | - | - | 10,5 | 76 | |
| | | | | | | | | | |

| | | | | | | | | | |
|--|---------------|----|----|------|----|---|---|------|----|
|  | TW0107 | 50 | 80 | 20X2 | == | - | - | 10,5 | 76 |
| | | | | | | | | | |

Serie 411



Aro

Rueda de poliamida gris
Cojinete: liso
Diámetro: 50mm
Capacidad de carga: 80Kg

Horquilla

Chapa de acero embutida
Acabado: cincado brillante
Tipo de fijación: pletina o agujero pasante
Doble rodamiento a bolas

www.alex.es

| Código | | | | Tipo Cojinete Eje | | | | | |
|---------------|----|----|------|-------------------|-------|-------|----|----|--|
| TW0102 | 50 | 80 | 20X2 | == | 60X60 | 43X43 | M6 | 76 | |

| | | | | | | | | | |
|---------------|----|----|------|----|-------|-------|----|----|--|
| TW0104 | 50 | 80 | 20X2 | == | 60X60 | 43X43 | M6 | 76 | |
|---------------|----|----|------|----|-------|-------|----|----|--|

| Código | | | | Tipo Cojinete Eje | | | | | |
|---------------|----|----|------|-------------------|---|---|------|----|--|
| TW0106 | 50 | 80 | 20X2 | == | - | - | 10,5 | 76 | |









| | | | | | | | | | |
|---------------|----|----|------|----|---|---|------|----|--|
| TW0108 | 50 | 80 | 20X2 | == | - | - | 10,5 | 76 | |
|---------------|----|----|------|----|---|---|------|----|--|

Aro

Rueda de polipropileno
 Cojinete: liso
 Diámetro: hasta 50mm
 Capacidad de carga: 30Kg

Horquilla

Chapa de acero embutida
 Acabado: cincado brillante
 Tipo de fijación: pletina (giratoria y fija)
 Una hilera de bolas

| | Código |  |  Kg |  | Tipo Cojinete Eje |  |  |  |  |
|---|---------------|---|--|---|-------------------|---|---|---|---|
|  | TW0128 | 25 | 10 | 12 | — | 38X32 | 30X24 | M4 | 35 |
| | TW0129 | 30 | 18 | 14 | — | 38X32 | 30X24 | M4 | 40 |
| | TW0130 | 40 | 20 | 17 | — | 46X38 | 36X28 | M5 | 50 |
| | TW0131 | 50 | 30 | 21 | — | 60X47 | 45X35 | M6 | 65 |
|  | TW0132 | 25 | 10 | 12 | — | 38X19 | 30 | M4 | 35 |
| | TW0133 | 30 | 18 | 14 | — | 38X19 | 30 | M4 | 40 |
| | TW0134 | 40 | 20 | 17 | — | 46X24 | 36X15 | M5 | 50 |
| | TW0135 | 50 | 30 | 21 | — | 60X42 | 45X25 | M6 | 65 |

Serie 420



Aro

Rueda de polipropileno negro
Diámetros: 40 - 50mm
Capacidad de carga: 20 - 50Kg

Horquilla

www.alex.es

| Código | | | | Tipo Cojinete Eje | | | | | |
|---------------|----|----|---|-------------------|-------|-------|----|----|--|
| TW0109 | 40 | 20 | - | - | 38x38 | 25x25 | M5 | 57 | |
| TW0110 | 50 | 50 | - | - | 38x38 | 25x25 | M5 | 67 | |

| | | | | | | | | | |
|---------------|----|----|---|---|-------|-------|----|----|--|
| TW0111 | 40 | 20 | - | - | 38x38 | 25x25 | M5 | 57 | |
| TW0112 | 50 | 50 | - | - | 38x38 | 25x25 | M5 | 67 | |











| Código | | | | Tipo Cojinete Eje | | | | | |
|---------------|----|----|---|-------------------|---|---|-------|----|--|
| TW0113 | 40 | 20 | - | - | - | - | 6x15 | 50 | |
| TW0114 | 50 | 50 | - | - | - | - | 8x15 | 63 | |
| TW0115 | 50 | 50 | - | - | - | - | 10x15 | 63 | |

| | | | | | | | | | |
|---------------|----|----|---|---|---|---|-------|----|--|
| TW0116 | 40 | 20 | - | - | - | - | 6x15 | 50 | |
| TW0117 | 50 | 50 | - | - | - | - | 8x15 | 63 | |
| TW0118 | 50 | 50 | - | - | - | - | 10x15 | 63 | |

Aro

Rueda de polipropileno negro
 Diámetros: 40 - 50mm
 Capacidad de carga: 20 - 50Kg

Horquilla

| | Código |  |  Kg |  | Tipo Cojinete Eje |  |  |  |  |
|---|---------------|---|--|---|-------------------|---|---|---|---|
|  | TW0119 | 50 | 50 | - | - | - | - | 8x26 | 62 |
|  | TW0120 | 50 | 50 | - | - | - | - | 11x22 | 61 |
|  | TW0121 | 50 | 50 | - | - | - | - | 11x22 | 61 |

Series 500 a 502



Serie 500

Llanta metálica y cubierta neumática
 Cojinete: bolas
 Lonas: 4
 Diámetro: 260mm
 Capacidad de carga: 175Kg

www.alex.es

| Código | Serie | | | | | | Tipo Cojinete Eje |
|---------------|-------|-----|-----|----|----|----|-------------------|
| TW0122 | 500 | 260 | 175 | 85 | 20 | 75 | |



Series 501 - 502

Llanta de plástico y cubierta neumática
 Cojinete: liso o rodillos
 Lonas: 4
 Diámetro: 260mm
 Capacidad de carga: 175Kg

| Código | Serie | | | | | | Tipo Cojinete Eje |
|---------------|-------|-----|-----|----|----|----|-------------------|
| TW0123 | 501 | 260 | 175 | 85 | 20 | 75 | |
| TW0124 | 502 | 260 | 175 | 85 | 20 | 75 | |

